

VGB21 Video Terminal

Installation and Operating Information

Order Number: EK-VGB21-IN. A01

April 1994

FCC ID: A09-VGB20

Note: This equipment has been tested and found to comply with the limits for a Class B digital device, pursuant to Part 15 of the FCC rules. These limits are designed to provide reasonable protection against harmful interference in a residential installation. Any changes or modifications made to this equipment may void the user's authority to operate this equipment.

This equipment generates, uses, and can radiate radio frequency energy and, if not installed and used in accordance with the instructions, may cause harmful interference to radio and television reception; however, there is no guarantee that interference will not occur in a particular installation. If this equipment does cause harmful interference to radio or television reception, which can be determined by turning the equipment off and on, the user is encouraged to try to correct the interference by one or more of the following measures:

- Re-orient or relocate the receiving antenna.
- Increase the separation between the equipment and the receiver.
- Connect the equipment to an outlet on a circuit different from that to which the receiver is connected.
- Consult the dealer or an experienced radio/TV technician for help.

ADDS is a trademark of Applied Digital Data Systems, Inc.

IBM, ProPrinter, and PS/2 are registered trademarks of International Business Machines Corporation. SCO is a trademark of Santa Cruz Operations, Inc. TVI is a trademark of TeleVideo, Inc. UNIX is a registered trademark of UNIX System Laboratories, Inc.

WY and WYSE are registered trademarks of Wyse Technologies.

The Energy Star emblem does not represent EPA endorsement of any product or service.

All Rights Reserved.
Printed in Taiwan.

This document was prepared using VAX DOCUMENT Version 2.1.

Contents

Preface	v
1 Installation and Set-Up	
1.1 Installation	1-1
1.2 Set-Up	1-5
2 Multiple Sessions	
2.1 Overview	2-1
2.2 Using a Terminal Server with TD/SMP	2-2
2.2.1 Using SSU Host Software	2-2
2.2.2 Opening Another Session	2-2
2.3 Tips for Using Multiple Sessions	2-3
3 Desktop Features	
3.1 Invoking Desktop Features	3-1
3.1.1 Clock feature	3-2
3.1.2 Calculator feature	3-3
3.1.3 Show Character Sets feature	3-4
3.1.4 Banner message	3-4
3.2 Keyboard Summary	3-5

4 Defining Keys

4.1	Define Key Editor	4-1
4.1.1	Creating a New Function	4-2
4.1.2	Creating a Key Sequence	4-3

A Maintenance and Troubleshooting

A.1	Cleaning your Video Terminal	A-1
A.2	Troubleshooting	A-1
A.3	Installing the ROM Cartridge	A-3

B Specifications

Figures

1-1	VT Keyboard Layout	1-4
1-2	PC-Style Keyboard Layout	1-4
1-3	Communications Port Set-Up Screen	1-9
4-1	Define Key Editor, Select Function	4-3
B-1	Comm1 and Comm2—Serial Communication/Printer Ports	B-4
B-2	Comm3—9-Pin EIA 232 Port	B-5
B-3	Parallel Printer Port (Bidirectional)	B-5

Tables

1	Recommendations for Proper Setup and Use	vii
A-1	Identifying and Correcting Problems	A-2
B-1	Standards Conformance and Approvals	B-6

Preface

Overview

This guide is for users who want to install and configure the VGB21 video terminal. This guide describes how to connect cables and enter the Set-Up menu to make changes, as needed. This guide also has reference tables for troubleshooting, specifications, and compose sequences.

For more detailed information on programming the terminal, refer to the *VGB20/VGB25 Video Terminal Programmer Information*.

Environment

Note

This product has been designed and manufactured to minimize the impact to the environment. The packaging is recyclable and the terminal can be returned for proper disposal. The terminal also has power management features that exceed the Environmental Protection Agency (EPA) Energy Star requirements for saving energy.

Before You Start

A small flat-blade screwdriver may be needed to install the communication or the printer cables.

Conventions

The following conventions are used in this document:

Convention	Meaning
<code>Caps Lock</code> <code>Print Screen</code>	Indicates two keys that you must press in combination. Press and hold the first key while you press the second key.
<code>Lock</code> <code>0</code>	Indicates two keys that you must press in sequence. Press and release the first key before you press the second.
<code>Caps Lock</code> <code>Alt</code> <code>F11</code>	Indicates three keys that you must press in combination, holding the first two down while pressing the third.
<i>kpd</i>	Indicates a key on the numeric keypad.

Proper Setup and Use

Important Information

Certain recent scientific literature suggests that poor posture, work habits, or office equipment setup may cause injuries. Other literature suggests that there is no cause and effect. Because the safety of our users is a great concern, it is important to take the precautions described in Table 1.

If you experience pain or discomfort while using the terminal, take a substantial break and review the instructions for posture and work habits. If your pain or discomfort continues when you resume using the terminal, discontinue use and report the condition to your job supervisor or physician.

Table 1 Recommendations for Proper Setup and Use

Adjust	So that your . . .
Chair	<ol style="list-style-type: none"> <li data-bbox="305 835 537 940">1 Feet are flat on the floor or footrest, if needed. <li data-bbox="305 953 537 1058">2 Legs are vertical forming a right angle to the floor. <li data-bbox="305 1071 537 1440">3 Weight is off your thighs and are in a horizontal position. Keep the back of your knees away from the seat so you do not compress the area behind them, which could restrict the blood flow. <li data-bbox="305 1453 537 1587">4 Upper body is erect and your lower back is supported with a backrest.
Keyboard	<ol style="list-style-type: none"> <li data-bbox="305 1600 537 1816">5 Wrists are straight and do not flex more than 15°. They may be supported but should not rest on sharp edges.

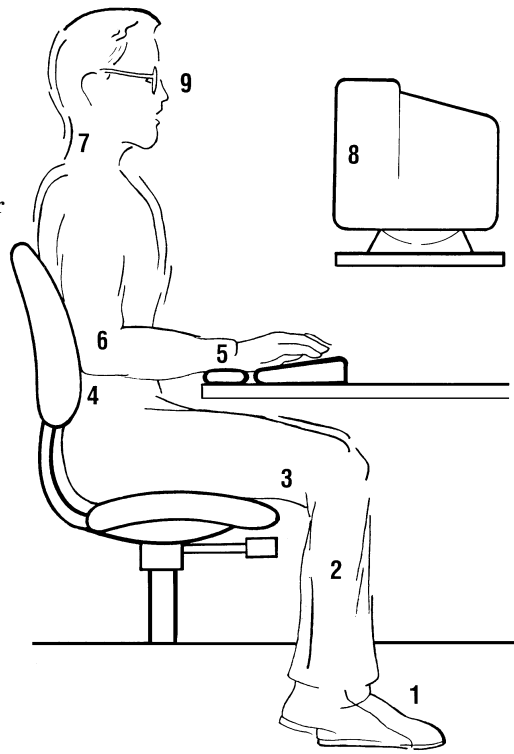

MA-0069-93.IL

(continued on next page)

Table 1 (Cont.) Recommendations for Proper Setup and Use

Adjust	To . . .
	6 Keep your upper arms straight down at your sides, elbows close to your sides to support your arm weight. Forearms should be at a 70° to 90° angle.
Head	7 Avoid neck strain. Your head should incline downward, but no more than 15° to 20°.
Terminal Eyes	8 Keep eye level and the correct distance for proper vision. 9 Avoid eye fatigue, which can be caused by glare, image quality, uncomfortable furniture, eye height, and uncorrected vision. If you cannot read the screen at different distances, you may need special glasses. Relax your eyes periodically by looking at distant objects.
Work Breaks	Take periodic work breaks. Morning, lunch, and afternoon breaks meet most recommendations. Take advantage of work breaks to move around and do other movements.
Lighting	Avoid direct lighting or sunlight on the screen, which causes glare and reflections. The terminal screen has an antiglare treatment to reduce glare. Place lighting behind or to the side of your work area, and distribute the lighting evenly on your work area. Adjust the terminal brightness and the contrast controls as needed.
Noise	Keep background noise at a minimum. Background noise above 65 dBA is tiring. Sound-absorbing materials, such as curtains, carpeting, and acoustic tile, can help reduce background noise.
Temperature	20°C to 23°C (68°F to 74°F)
Humidity	30% to 70%
Ventilation	Provide adequate air ventilation for equipment operation and to avoid fatigue.
Space between terminals	More than 70 cm (28 in) center to center, preferably more than 152 cm (60 in).

1

Installation and Set-Up

1.1 Installation

Install the tilt/swivel stand.

1. Insert the hooks on the stand into the slots at the bottom of the terminal.
2. Slide the stand to the right until it is locked by the two tabs at the bottom of the terminal. (To remove the stand, press the two tabs.)

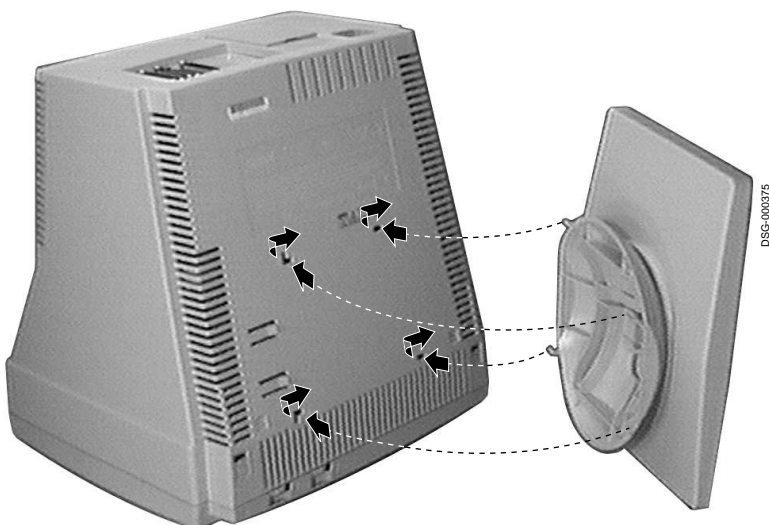

Installation and Set-Up

1.1 Installation

Connect the cables to the terminal.

Connect the cables to the terminal as shown, and plug the power cord into an ac electrical outlet.

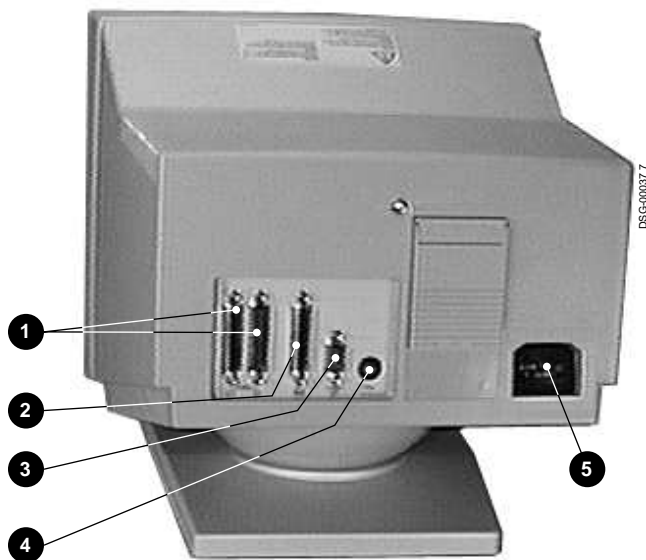

- ❶ Comm 1, Comm 2 (\Rightarrow) (f), ❷ Parallel (\parallel) (f),
❸ Comm 3 (m) (Serial printer), ❹ Keyboard, ❺ Power cord.

Installation and Set-Up

1.1 Installation

Push the power switch on.



❶ Power, ❷ Contrast, ❸ Brightness

Power Up Selftest

The terminal takes a few seconds to warm up and complete its power up self-tests. Then, the terminal should display “**Selftest OK.**” If a problem occurs, go to the Appendix A.

Installation and Set-Up

1.1 Installation

Keyboards

Figure 1-1 VT Keyboard Layout

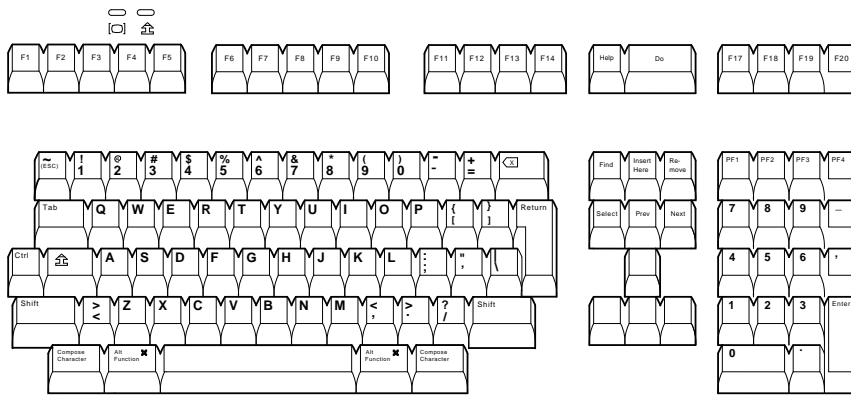

MA-1520a-92.PS

Figure 1-2 PC-Style Keyboard Layout

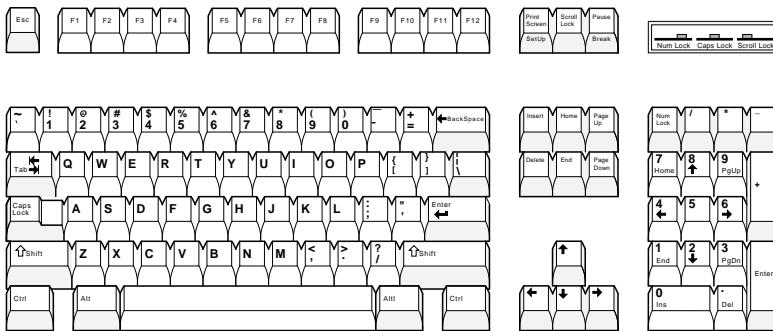

LJ-00226a-T10.PS

Installation and Set-Up

1.2 Set-Up

1.2 Set-Up

Overview

Use Set-Up to examine or change the terminal operating features. The Set-Up menu summary at the bottom of the screen are the communication features to get you started in operating the terminal. There are many more Set-Up features in the terminal that you may wish to change.

Before changing the communication Set-Up features, contact your System Manager if necessary.

Printer operations are suspended upon entering Set-Up and are resumed upon exiting Set-Up.

Entering/Exiting Set-Up

To enter or exit Set-Up, perform the following procedures:

On a . . .	Press . . .	Refer to . . .
VT keyboard	F3	Figure 1-1
PC keyboard	Caps Lock Print Screen	Figure 1-2

Installation and Set-Up

1.2 Set-Up

Moving within a Set-Up Menu

Use the arrow keys (, , ,) to move among the menus or within a list, or to select buttons.

In a menu . . .	Indicates . . .
▷	A pull-right submenu is available.
. . .	A dialog box is available for you to specify more information.
• a	The menu item with the filled-in circle is enabled. Only one of these items can be enabled at a time.
◦ b	
◦ c	
<input type="checkbox"/>	The menu item with the checkbox is enabled.

Press , , , or to start the action or to choose the currently highlighted feature.

A dimmed menu item does not apply to the currently selected mode.

Caution

If you disable the **Display ▷ CRT Saver** feature, an image may etch onto the screen, which may shorten the terminal's useful life.

Installation and Set-Up 1.2 Set-Up

Select the Set-Up language.

This language selection is for Set-Up only and does not affect keyboard, character set, or printer settings. As you make changes to some Set-Up parameters, the Set-Up summary line will reflect those changes.

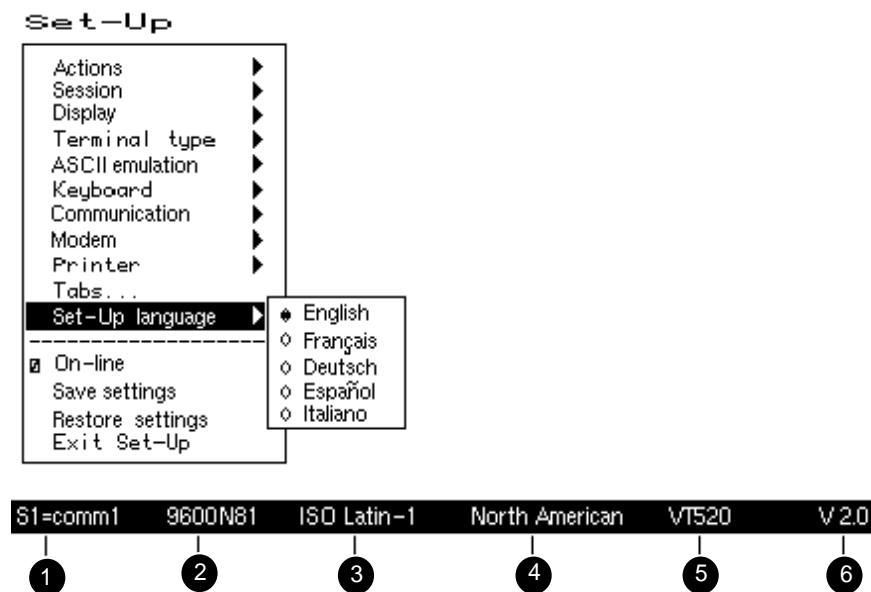

- ① Port selected, ② Transmit speed (9600), Parity (N), Word size (8), Stop bits (1), ③ Character set, ④ Keyboard language, ⑤ Emulation mode, ⑥ Firmware version.

Installation and Set-Up

1.2 Set-Up

Configuration

The VGB21 allows you to open up to four sessions depending on the communications connections and the host software. As a minimum for each session (S1, S2, S3, and S4), determine the following menu items, and note any change here that you make from the default value.

Menu item	Default	S1	S2	S3	S4
Terminal type ▸ Emulation mode	VT520	_____	_____	_____	_____
Keyboard ▸ Keyboard language	English	_____	_____	_____	_____
Communication ▸ Port select	See Figure 1–3.	_____	_____	_____	_____
Communication ▸ Word size	8 bits	_____	_____	_____	_____
Communication ▸ Parity	None	_____	_____	_____	_____
Communication ▸ Transmit speed	9600 baud	_____	_____	_____	_____
Communication ▸ Receive speed	Transmit speed	_____	_____	_____	_____
Printer ▸ Printer type	ANSI ¹	_____	_____	_____	_____

¹American National Standards Institute

Installation and Set-Up 1.2 Set-Up

Notes

For a session to be enabled, it must be assigned to a comm port. If you assign more than one session to the same comm port, you must use a terminal server that supports Terminal Device Session Management Protocol (TD/SMP), or a host that supports Session Support Utility (SSU).

A port cannot be assigned as both a comm port and a printer port at the same time.

Selecting Comm = “• none” disables a session. A session that is dimmed is disabled, but it can still be configured in Set-Up.

Figure 1-3 Communications Port Set-Up Screen
Set-Up

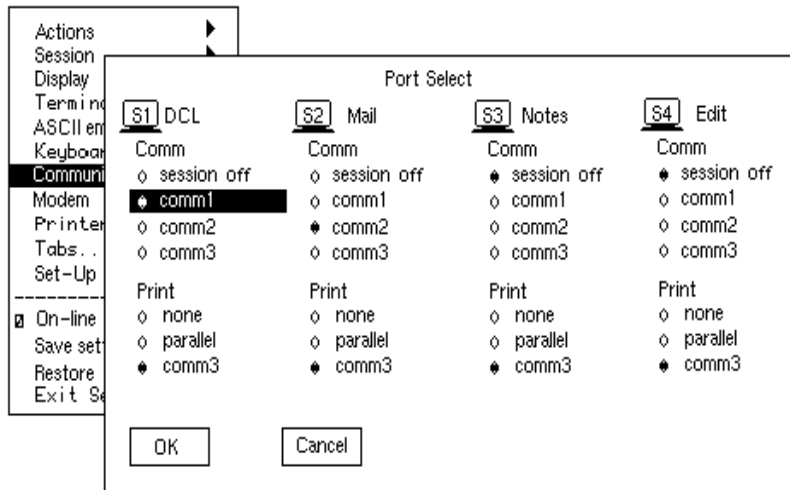

MA047493.GRA

Installation and Set-Up

1.2 Set-Up

Save your settings.

Use one of the following procedures:

Save . . .	Select menu item . . .
Active session only	Save settings
All sessions	Session ▸ Save settings for all

Then, press **Enter** or **Return**.

Restore previously saved settings.

Use one of the following procedures:

Restore . . .	Select menu item . . .
Active session only	Restore settings
All sessions you saved	Session ▸ Restore settings for all
Factory defaults for all sessions	Action ▸ Restore factory defaults

Then, press **Enter** or **Return**.

2

Multiple Sessions

2.1 Overview

Multiple sessions extends the VGB21 to act like four terminals in one. A *session* is an active connection between the terminal and a host system. See Figure 1–3.

The VGB21 supports up to four sessions using virtual terminals. Each virtual terminal maintains the full keyboard and display state of a real physical terminal but shares a single keyboard and display with other virtual terminals. Before you can login using a virtual terminal, it must be connected to a host computer.

VGB21 session virtual terminals can be connected directly to a host computer through any of the three serial communication ports on the back of the terminal. Since there are only three comm ports, this method alone can only support three sessions.

To use a fourth session or to reduce the number of serial comm lines needed, more than one session must be connected through a single comm port. The VGB21 allows this using a session management protocol, called TD/SMP (Terminal Device/Session Management Protocol). TD/SMP allows two or more sessions to share a single comm line, as long as the other end of the comm line supports the protocol. To enable TD/SMP at the terminal, you simply assign more than one session virtual terminal to the same comm port in Set-Up.

TD/SMP is available on most terminal servers or host systems with SSU software. If you are using a terminal server, check with its documentation to determine if it can run TD/SMP.

Multiple Sessions

2.2 Using a Terminal Server with TD/SMP

2.2 Using a Terminal Server with TD/SMP

At the `Local>` prompt, enter the following command:

```
Local> set port multi enable 
```

Continue with your login procedure.

To permanently set a terminal server port to use TD/SMP, type:

```
Local> define port multi enable 
```

2.2.1 Using SSU Host Software

If your VGB21 is connected directly to a host computer without a terminal server, you can still use TD/SMP by running the Session Support Utility (SSU) on your host computer. On a system that has SSU software, such as OSF/1 or OpenVMS, enable sessions as follows:

```
$ SSU ENABLE 
```

2.2.2 Opening Another Session

Once TD/SMP is enabled, you can open a new session and switch between them as follows:

1. Press the (Session) key on a VT keyboard; or press *kpd* on a PC keyboard.
2. To go directly to a particular session, press , , or on the numeric keypad. The session number for the current session is displayed at the lower left of the screen.

Multiple Sessions

2.3 Tips for Using Multiple Sessions

2.3 Tips for Using Multiple Sessions

- You can display data from two sessions at the same time by dividing the screen into two windows. Press `Ctrl|F4` (Session) or `Ctrl|Caps Lock|0|kpd` to change the window configuration.
- When you choose **Display ▸ Framed windows**, you can assign a 30-character name to each session for the window title bar. The first 12 characters of the session name become the session icon name. If the title is a valid host or service name, a terminal server will try to automatically open a connection to that service.
- If you allow a session to be updated from the host, when new data is received that has not been displayed, the session icon at the top of the screen blinks.
- To enable two or more sessions to use the same settings, configure either one, then use **Copy settings from** in the session menu to copy the desired settings to other sessions.
- You can control the number of pages of display memory available to each session from Set-Up by using the **Pages per session...** dialog. The typical terminal has eight pages total. Before you increase pages in one session, you may need to reduce the pages assigned to other sessions. Any data on pages affected will be erased.
- If the session context between the terminal and host is lost due to a power failure or other interruption, you can usually restore the previous session context without starting over by pressing `F4` or `Ctrl|Caps Lock|0|kpd`.
- The terminal automatically enables session management when you assign more than one session to a single comm port.

3

Desktop Features

3.1 Invoking Desktop Features

Overview

From the **Actions** menu, you can invoke **Clock**, **Calculator**, **Show character sets** and the **Banner message**. When the feature is highlighted (displayed in reverse video), press **Enter** or **Return** to enable the feature. A quick start summary of some keyboard features is provided, as well as how to implement the **Accessibility Aid** feature and the **Copy and Paste** function. You can copy and paste within a session and between sessions. Within Set-Up, there are many more features like **Review previous lines** on a page and check the **screen alignment**.

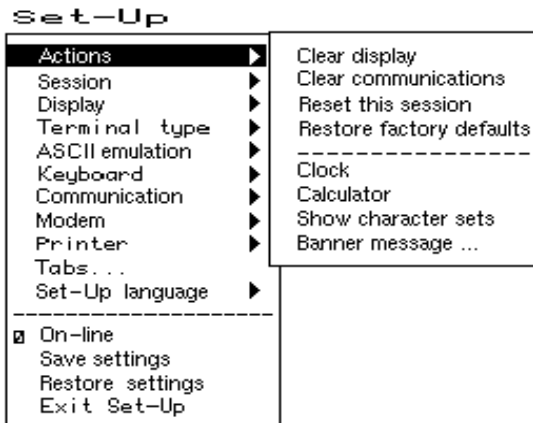

MA06993.GRA

Desktop Features

3.1 Invoking Desktop Features

While these desktop features are enabled, other terminal functions are disabled. Press **Ctrl****Z**, **F10**, **Exit**, or **Esc** to exit the feature.

3.1.1 Clock feature

You can enable the **Clock** feature without entering Set-Up by pressing **Caps Lock** **Alt****F11** if you are either in a VT or an SCO console emulation mode.

The current time is displayed in the status line if this feature is enabled. The format is HH:MM, followed by AM or PM if the 12-hour format is selected. Use the following keys within the clock feature:

Key	Function
↓ or Tab	Go to next field.
↑ or Shift Tab	Go to previous field.
← or →	Move within a field.
Return or Enter	If desired, check the 24-hour format box. For example, before entering 13:00, enable 24-hour format .
A or P	For 12-hour format, set the time to morning by pressing A or P for afternoon.
Caps Lock Enter	Input the clock time at the cursor position and exit the clock.

If the clock feature is enabled, then the alarm sounds for five seconds or until a key is pressed. Each alarm message can be up to 20 characters and will be displayed in the status line until a key is pressed. If the hourly chime is enabled, then the terminal will beep once every hour. In Set-Up, select the **Save settings** menu item to save the time format. The clock feature is disabled when the terminal is turned off.

Desktop Features

3.1 Invoking Desktop Features

3.1.2 Calculator feature

If you are either in a VT or an SCO console emulation mode, you can enable the **Calculator** feature without entering Set-Up by pressing **Caps Lock** **Alt** **F12**.

In addition to the numbers on the numeric keypad, you can use the following keys with the calculator:

Key	Function
H , O , or D	Selects hexadecimal H , octal O , or decimal D format.
Arrow keys	Move the position of the calculator on the screen.
Shift	Changes the keypad display to allow selecting STO , RCL , 1/x , X² , and Insert Result .
Alt	Changes the keypad display to hexadecimal and allows selecting A through F <i>kpd</i> .
C/E	Clears the entry.
STO	Stores the number in the display into memory.
RCL	Recalls the number from memory and places it in the display.
Shift Enter	Inserts the result at the current cursor position after exiting the calculator feature.

All calculator math operations have equal priority except $1/x$ and x^2 . If a result is wider than the display, then a rounded number will be displayed. The non-rounded result will continue to be used in subsequent calculations. The decimal point cannot be used with the hexadecimal mode.

Desktop Features

3.1 Invoking Desktop Features

3.1.3 Show Character Sets feature

If you are in either a VT or an SCO console emulation mode, you can enable the **Show character sets** desktop feature without entering Set-Up by using `Caps Lock Alt F10`. When the character set is displayed, you can use the following keys with this feature:

Key	Function
<code>Next</code> or <code>Prev</code>	Looks through the available character sets.
<code>Page Up</code> or <code>Page Down</code>	
<code>Shift A</code>	Restores the character set.
<code>Shift L</code>	Displays the line drawing character set, if you are using a VT character set.
<code>Shift T</code>	Displays the technical character set.
<code>Shift Enter</code>	For the current character set, inserts the highlighted character into text at the current cursor position, if you are using a VT character set.

3.1.4 Banner message

The Banner message is the message that is displayed when you turn the terminal on. You can change this message as desired. From the **Actions** menu, select **Banner message...**

1. Press `Return` or `Enter` to display a dialog box.
2. Enter your banner message.
3. Press the `↓` to select the `OK` button.
4. Press `Return` or `Enter` to return to the Set-Up menu.

Desktop Features 3.2 Keyboard Summary

3.2 Keyboard Summary

The following table provides a quick start summary of some keyboard features.

To ...	VT Keyboard, press ...	PC Keyboard, press ...
Hold the screen	F1	Scroll Lock
Print the screen	F2	Print Screen
Enter/Exit Set-Up	F3	Caps Lock Print Screen
Switch session	F4 or Caps Lock 0	Caps Lock 0 <i>kpd</i>
Select specific session	Caps Lock 1, 2, 3, or 4	Caps Lock 1, 2, 3, or 4
Break	F5	Caps Lock Pause
Toggle split screen	Ctrl F4	Ctrl Caps Lock 0 <i>kpd</i>
Adjust window size	Ctrl Shift ↑ or ↓	Ctrl Shift ↑ or ↓
Pan or Review previous lines	Ctrl ↑ or ↓	Ctrl ↑ or ↓
Copy and paste:		
Start copy	Hold down F1 †	Hold down Scroll Lock
Move to beginning of text	← , → , ↑ , or ↓	← , → , ↑ , or ↓
Select beginning of text	Select ‡	Home ‡
Select end of text	Remove	End
Finish copy	Release F1	Release Scroll Lock
Move to different session if desired.		
Paste	F1 Insert Here	Scroll Lock Insert

†For SCO console, press **Caps Lock** | **F1**.

‡If you press the **Select** key (or **Home** key) twice, the keyboard will toggle the copy direction between left-to-right and right-to-left directions for use with right-to-left scripts.

Desktop Features

3.2 Keyboard Summary

Accessibility aid

This feature allows a user with limited motor skills to use modifier key combinations in a sequential manner rather than in a simultaneous manner. All modifier key combinations are supported. There are two operation states—Latch and Lock. The *Latch state* affects only the next key pressed. When in the *Lock state*, all keys pressed are affected by the modifier until you press the same modifier key again or press any other modifier key twice. A small icon indicating the state is displayed on the Keyboard Indicator Line or the Status Line.

- To enable:** Press any modifier key five times.
- Latch state:* Press any modifier key once.
- Lock state:* Press any modifier key twice.
- To disable:** Press and hold a modifier key while you press another key.

Review previous lines

In Set-Up or through software, you can allocate the pages are assigned to each session, up to a total of eight pages. When **Review previous lines** is selected, the page memory allocation for a session becomes a *single page* and a *scroll back buffer*. You can then use **Ctrl**↑ and **Ctrl**↓ keys to scroll up or down to review lines previously scrolled off the screen. (Note: When this feature is enabled, the host cannot write to specific pages, and control codes from the host are ignored.)

Screen alignment

With this feature, you can use the arrow keys to adjust the screen position.

4

Defining Keys

4.1 Define Key Editor

Overview

This terminal provides a powerful Define Key Editor that allows you to modify the function of keys on your keyboard. Since keystrokes can perform many different functions, it will take some practice to understand how the keys work. This section is an introduction to customizing your keyboard.

Moving Standard Functions

The simplest way to re-program a key is to copy the behavior of another key. The following method allows you to move factory default key functions to any position on the keyboard:

1. From the **Keyboard** menu item, select the **Define key . . .** function, and the **Define Key Editor** menu will appear.
2. Press the key you want to define.
3. Choose **Copy of key default** and press `[Enter]`.
4. Press the key you want to copy.
5. Choose the **OK** or **Apply** button and press `[Enter]`.

Names are displayed in the Set-Up language selected (not according to the keyboard language). They are truncated to 12 characters in the definition field. The \pm symbol indicates a toggle feature. Copying does not affect the function of the key being copied. The terminal always copies the standard function of the chosen key, even if you have redefined that key. You can undo a mistake by copying the default values of a key to itself.

Defining Keys

4.1 Define Key Editor

Function Keys

Function keys are used to transmit function key sequences or to perform local terminal functions such as the arrow keys (↑, ↓, ⇒, ⇐), the **[Shift]** modifier key, or the key that calls up the Set-Up menu (F3). A *User Defined Key* (UDK) is a special function key.

Modifier Keys

A modifier key is a key that modifies the behavior of other keys when it is pressed and held down. For example, pressing an alphanumeric key in combination with the **[Shift]** modifier key will normally send the shifted or uppercase characters for that key.

Modifier keys are treated as a special kind of local terminal function. The function modifier keys are: **[Shift]**, **[Ctrl]**, and **[Alt]**. Alphanumeric keys can also be modified by pressing **[Group Shift]** (**[Alt Gr]** on enhanced PC keyboards) and **[Alt|Shift]** (Shift-2). Modifier keys themselves cannot normally be modified by other keys. A key assigned to act as the **[Shift]** modifier, for example, cannot transmit a function sequence when pressed in combination with the **[Alt]** key. Defining a key as a modifier key makes all assignable combinations of that key act as a modifier. Example: Changing the **<X>** key to delete when unshifted and to backspace when shifted.

4.1.1 Creating a New Function

To define a new function key within the Define Key Editor:

1. From the **Keyboard** menu item, select the **Define key . . .** function, and the **Define Key Editor** menu will appear.
2. Press the key you want to define.
3. Choose the **Function** button and press **[Enter]**. A screen similar to Figure 4-1 is displayed.
4. Press the modifier key sequence you want to define (unshifted, shifted, control, and so on) and press **[Enter]**.
5. Choose the desired function from the **Select function** scroll box and press **[Enter]**.

Defining Keys

4.1 Define Key Editor

Figure 4-1 Define Key Editor, Select Function

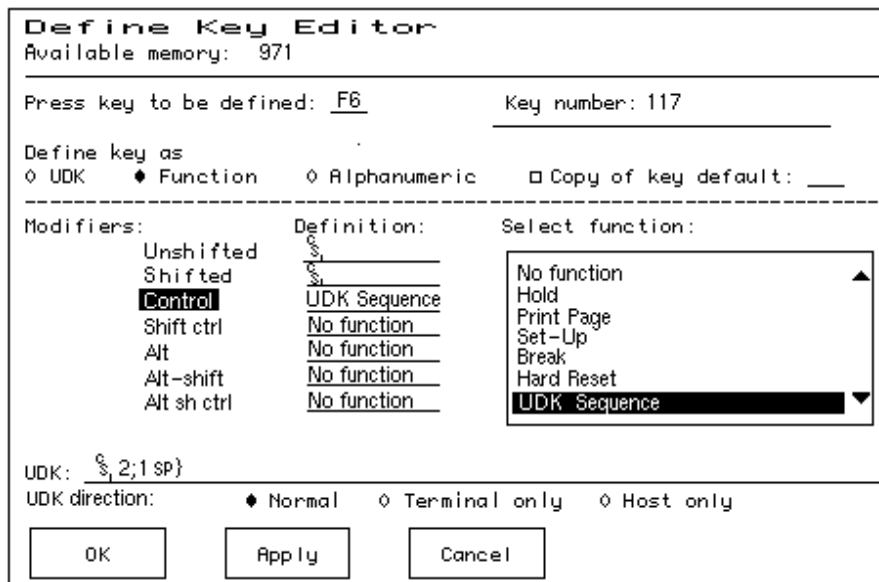

MA-0324-93.GRA

- Repeat steps 4 and 5 to define other modifier sequences.
- Choose the **OK** or **Apply** button and press **[Enter]**.

Example: Disabling the **[Compose]**, **[Break]**, or **[Set-Up]** key by assigning them to have no function.

4.1.2 Creating a Key Sequence

To define a key sequence:

- From the **Keyboard** menu item, select the **Define key . . .** function, and the **Define Key Editor** menu will appear.
- Press the key for which you want to define.
- Choose the **UDK** button at the upper left and press **[Enter]**.
- Choose the modifier sequence you want to define (unshifted, shifted, control, and so on) and press **[Enter]**.

Defining Keys

4.1 Define Key Editor

5. Enter a key sequence, such as a print queue.
Example: Print my file
6. Press the key to select where the sequence is to be sent:
 - Normal To video screen and/or host depending on communication setting (on-line, half-duplex, local).
 - Terminal only To video screen only.
 - Host only To central host computer.
7. Choose the **OK** or **Apply** button.

NOTE

Pressing the Set-Up key to exit Set-Up will activate the OK button to keep any changes you have made. If you redefine a key, you can always restore the default key functions from the **Actions** menu in Set-Up.

A

Maintenance and Troubleshooting

A.1 Cleaning your Video Terminal

Cleaning the Screen

Before cleaning the screen, set the terminal power switch to the off position and wait 20 seconds to let static electricity dissipate.

Clean the screen with a video screen cleaner.

Cleaning the Keyboard

If needed, wipe the keys with a soft cloth. Do not allow moisture to get under the keys.

A.2 Troubleshooting

Identifying and Correcting Problems

The following can be sources of problems:

- Communications cables
- Host system
- Power or electrical sources
- Adjustment of brightness or contrast controls

Maintenance and Troubleshooting

A.2 Troubleshooting

Troubleshooting Table

Use Table A–1 to identify and correct any problem areas.

Table A–1 Identifying and Correcting Problems

Symptom	Possible Cause	Suggested Solution
The printer will not print.	Communication port is not set correctly.	From the Communication menu item, choose Port select and match the connections on the terminal.
	If you have a serial printer, its speed may be set incorrectly.	From the Printer menu item, choose Serial print speed and match the setting to the one in your printer manual.
Modifier keys remain in effect after released.	Accessibility aid is enabled.	Check keyboard indicator line for icon. This feature is enabled by pressing any modifier key five times. To disable, press and hold a modifier key and then press another key.
Screen is blank, but the LED is blinking.	Power Management feature is active.	Press any key on the keyboard. The monitor may need time to warm up.

Maintenance and Troubleshooting

A.3 Installing the ROM Cartridge

A.3 Installing the ROM Cartridge

Introduction

The terminal can accommodate an optional ROM cartridge at the back of the terminal. This ROM cartridge will completely supersede the factory-installed software within the terminal for new software versions or special applications.

When an option ROM is not used, the ROM cartridge holder is empty with a cover over it.

Installing and Removing the ROM Cartridge

To install a ROM cartridge:

CAUTION

To prevent damage to the terminal, set the power switch to the off position before installing or removing the ROM cartridge.

1. Set the power switch to the off position.
2. Remove the cartridge by lifting the cover from the bottom and gently pulling it straight back.
3. Plug in a ROM cartridge with its attached cover and close the cover.

If you are having the terminal serviced, then remove and save the ROM cartridge. To remove a ROM cartridge, lift its cover from the bottom and gently pull it straight back.

To restore the firmware from the ROM cartridge:

1. Turn the power on and press **[F3]**.
2. Select **Actions** ▸ **Restore factory defaults** and press **[Return]**.
3. Select **Save settings** and press **[Return]**.

B

Specifications

Video Terminal

The following are the specifications for the VGB21 video terminal.

Dimensions

Height	32 cm (12.6 in)
Width	31.5 cm (12.4 in)
Depth	33 cm (13 in)

Weight 7.9 kg (17.4 lb)

Tilt Range 25° (5° forward, 20° backward)

Swivel Range ± 90° (left and right)

Display

Cathode ray tube (CRT)	35 cm (14 in) diagonal antiglare flat-profile screen
Overscan	72 Hz, 800 × 432, 88 DPI, 10 × 16 font
Non-overscan	72 Hz, 802 × 480, 88 DPI, 10 × 16 font
Usable area	17 cm (6.7 in) × 23 cm (9 in); 1:1.4 aspect ratio
No. of lines	25, 42, or 53 data lines
Page size	Selectable 24, 25, 36, 42, 48, 50, and 72 lines (emulation dependent)

Operating Systems Supported UNIX, MDOS, OpenVMS, OSF, ULTRIX, VMS, or any other that supports ASCII or ANSI protocols.

Terminal Emulations ANSI, PCTerm, and ASCII emulations: VT, WYSE, TVI, ADDS, or SCO console.

Specifications

Character Set Support	Multiple languages using ISO and IBM code pages; Set-Up selectable in five languages.
Productivity Features	Local copy and paste Time-of-day clock—sound alarms and display messages; insert time into text. Desktop calculator—insert result into text Show character sets—insert character into text
ROM cartridge support	4-Mbit (512 K byte) customer-installable ROM cartridge that completely replaces the factory-installed ROM code for new versions of the terminal's firmware.
Electrical Requirements	
AC input voltage	110, 120, 220, 230, 240 Vac auto-sensing single phase, 3-wire
Line frequency	47 Hz to 63 Hz
Power consumption	15 watts maximum
Operating Temperature	10°C to 40°C (50°F to 104°F)
Humidity	10% to 90% relative humidity Maximum wet bulb = 28°C Minimum dew point = 2°C (noncondensing)

Specifications

Keyboard

The terminal is designed to support industry-standard PS/2 compatible keyboards. Due to the large number of keyboard variations, it is not possible to test all of them in advance.

Keyboards from some manufactures may not function correctly due to differences in their implementation of the standard.

Keyboard style	ANSI style layout; enhanced PC 101/102 style layout; available for most European languages.
Protocol	IBM enhanced PS/2-compatible
Connector	PS/2-style, 6-pin mini DIN
Keyboard keys	All keys are programmable for single characters, character sequences, or local functions.
Compose characters	Compose character are available in Multinational, ISO Latin 1, ISO Latin 2, ISO Latin-Greek, and National Replacement character sets (NRCS) for VT keyboards, except Canadian-English, Danish, Dutch, Hebrew, Hungarian, Italian, Norwegian, Polish, Romanian, Russian, SCS, Turkish-F, Turkish-Q, UK, and US keyboards.
Nonvolatile memory	970K bytes memory User-defined key maximum length = 255 bytes.

Specifications

Communication/Printer Ports

Serial Bidirectional serial communication/printer ports with full modem support at 300 to 115.2K baud:

EIA 232

Comm 1¹ (Figure B-1):
25-pin D-sub f
Comm 2 25-pin D-sub f

EIA 423

Comm 3 (Figure B-2):
9-pin D-sub m

Parallel Centronics (25-pin D-sub f) parallel printer connector (Figure B-3).

¹An MMJ adapter can be used on Comm 1 for EIA-423 communication cables with a maximum cable of 76 m (250 ft).

m = male; f = female

Figure B-1 Comm1 and Comm2—Serial Communication/Printer Ports

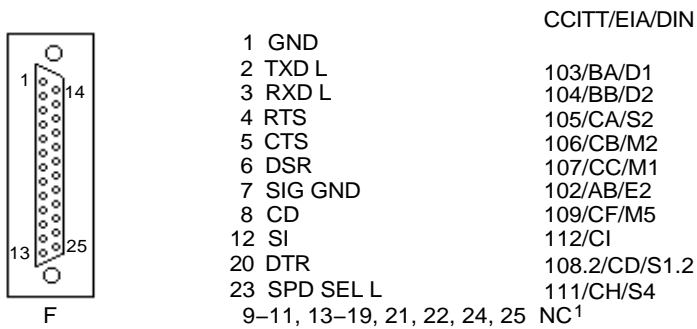

MA-0019A-93.GRA

Specifications

¹NC = not connected.

Figure B-2 Comm3—9-Pin EIA 232 Port

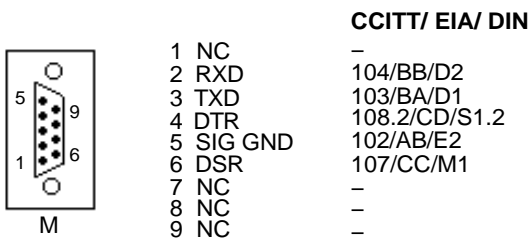

MA-0021-93.GRA

Figure B-3 Parallel Printer Port (Bidirectional)

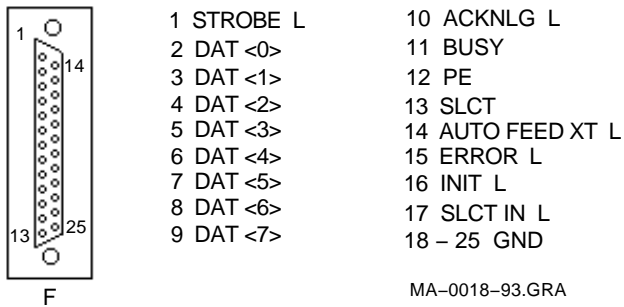

MA-0018-93.GRA

Specifications

Standards Conformance

Acoustic Noise Preliminary declared values per ISO 9296 and ISO 7779:

Product ¹	Sound Power Level		Sound Pressure Level ²	
	Idle	Operate	Idle	Operate
VGB21	<3.9	<3.9	<20	<20
PCXAL	NA	6.0	NA	51
PC7XL	NA	5.3	NA	47
LK411	NA	5.6	NA	52

¹Current values for specific configurations are available from service representatives. (1 B = 10 dBA.)

²Operator position.

Table B-1 Standards Conformance and Approvals

Type	Standard	Subject
Communications	EIA 423 EIA 232-E	Serial communications
	CCITT V.24 and V.28 NET 2 test report	Serial communications – Australia PTT German PTT Japan PTT Sweden PTT
EMI/RFI	CISPR-22 Class B CSA 108.8	Electromagnetic compatibility DOC Canada North American Class B version
	FCC part 15 Class B Vfg 243/91, Amd Vfg 46/92 Class B	Electromagnetic compatibility

(continued on next page)

Specifications

Table B-1 (Cont.) Standards Conformance and Approvals

Type	Standard	Subject
	CE Class B (EN55022 Class B, EN50082-1 Class 1) EN60555-2	Radio Protection Mark CE label
	ITE Class 2 (Japan)	VCCI Electromagnetic compatibility
Energy	"Energy Star"	EPA Energy Star requirements
	Alternative "A"	NUTEK energy requirements
Ergonomic	ZH1/618, GS-VS-SG7, EN29241-3	TÜV Ergonomic Requirements
Safety	CSA 22.2 #950 M1989	Safety of Information Technology Equipment Including Electrical Business Equipment (Canada)
	AS3260	Australia product safety
	DHHS rules 21 CFR, Subchapter J	U.S.A. DHHS (FDA)
	TÜV EN60950 (IEC 950) 2nd ed (1988) EN60950 (Amd 1 & 2, 1990)	Safety of Information Technology Equipment Including Electrical Business Equipment
	German X-Ray Act RöV §5(2) SS 436 14 90, MPR II; VDE0805 and Amd	GS-Mark (Geprüfte Sicherheit)
	EMKO-TSE (74-SEC) 203/92, DEMKO, NEMKO, SEMKO	Nordic Country Approvals
	UL 544 (2nd ed)	Standard for Medical and Dental Equipment

(continued on next page)

Specifications

Table B-1 (Cont.) Standards Conformance and Approvals

Type	Standard	Subject
	UL 1950 (2nd ed)	Safety of Information Technology Equipment Including Electrical Business Equipment

EMI Requirements for Canadian Market This equipment does not exceed the Class B limits for radio noise emissions from digital apparatus as set out in the Radio Interference Regulation of the Canadian Department of Communications.

Asbestos Asbestos is not used in this product or in its manufacturing process.

Flame Retardants The thermoplastic enclosures do not contain polybrominated diphenylether (PBDE) as a flame retardant additive; therefore, they do not emit toxic dibenzofuran and dibenzodioxin gases.

PVC The plastic enclosures are not made of rigid PVC. The material has a non-halogenated, flame-retardant system and is cadmium free.

Ozone Depleting Substance The VGB21 is in full compliance with the labeling requirements in the U.S. Clean Air Act Amendments of 1990. It does not contain, nor is it manufactured with, a Class 1 ODS, as defined in Title VI Section 611 of this act.

Disposing of your Terminal

Warning

If you need to dispose of your terminal, ask a qualified service representative for the proper disposal procedures. Improper disposal could result in personal injury. The terminal can be returned for proper disposal.
